

CREATE
YOUR STYLE
with SWAROVSKI ELEMENTS

DESIGN PROJECT

EASTER EGG CARD



EASTER EGG CARD



SWAROVSKI ELEMENTS

Article	Product Group	Article No.	Amount	Size	Color	Color Code
	Beads	5000	2 pcs.	6 mm	Aquamarine	202
	Beads	5000	2 pcs.	6 mm	Pacific Opal	390
	Beads	5754	2 pcs.	6 mm	Provence Lavender	283
	Beads	5754	1 pc.	8 mm	Fern Green	291
	Pendants	6690	2 pcs.	23 mm	Crystal	001

Supplies & Tools

- Supplies**
- Cardboard, light blue, 36x17 cm
 - Embroidery thread, grass green, 1 m
 - 1 Pattern paper, blue, 12x9 cm
 - Ribbon, light green, 8 cm, Ø 0.7 cm
 - Ribbon, turquoise, 8 cm, Ø 0.7 cm

- Tools**
- Beading needle
 - Cutter
 - Double sided sticky tape
 - Glue
 - Pin
 - Scissors
 - Sheet of paper

Level of design: BEGINNER

Have also a look at the **text instruction** at the last page!

STEP 1

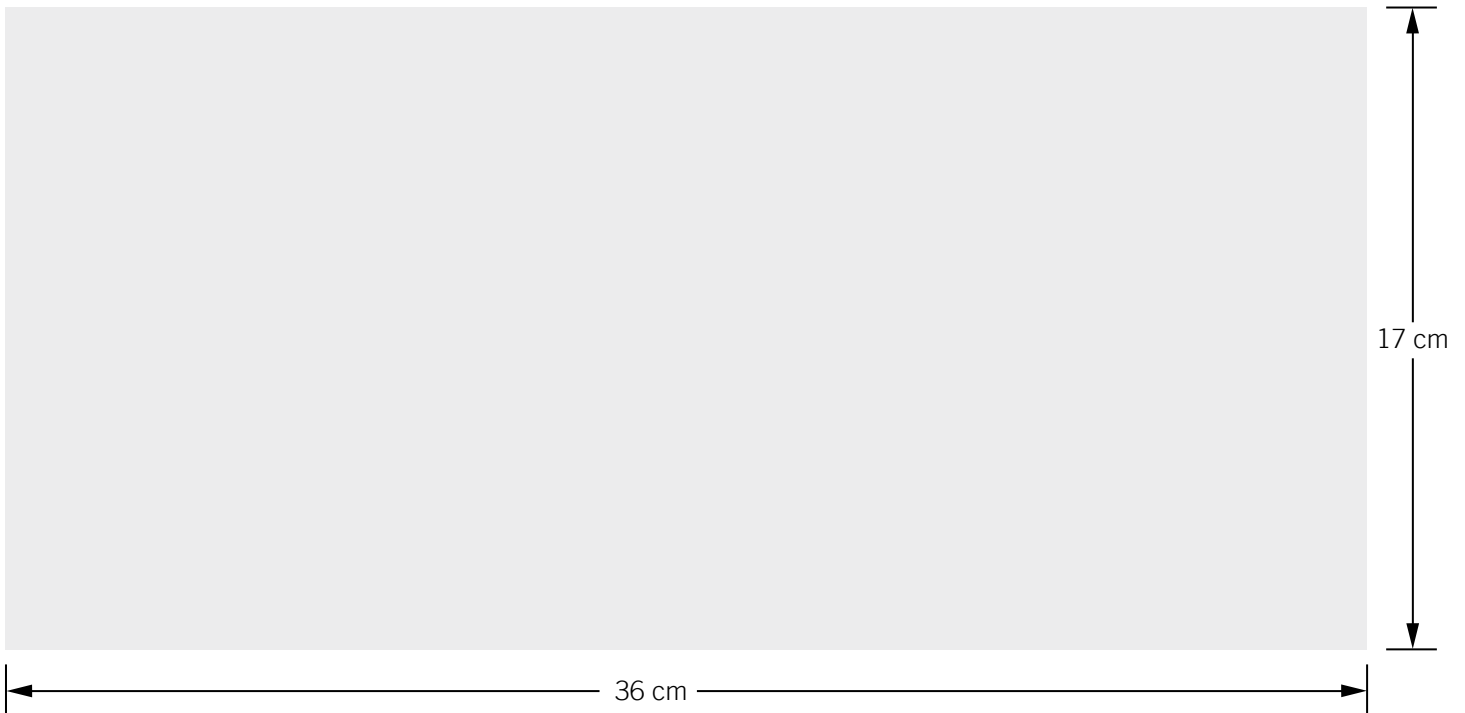

STEP 2

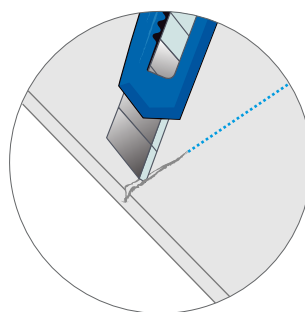
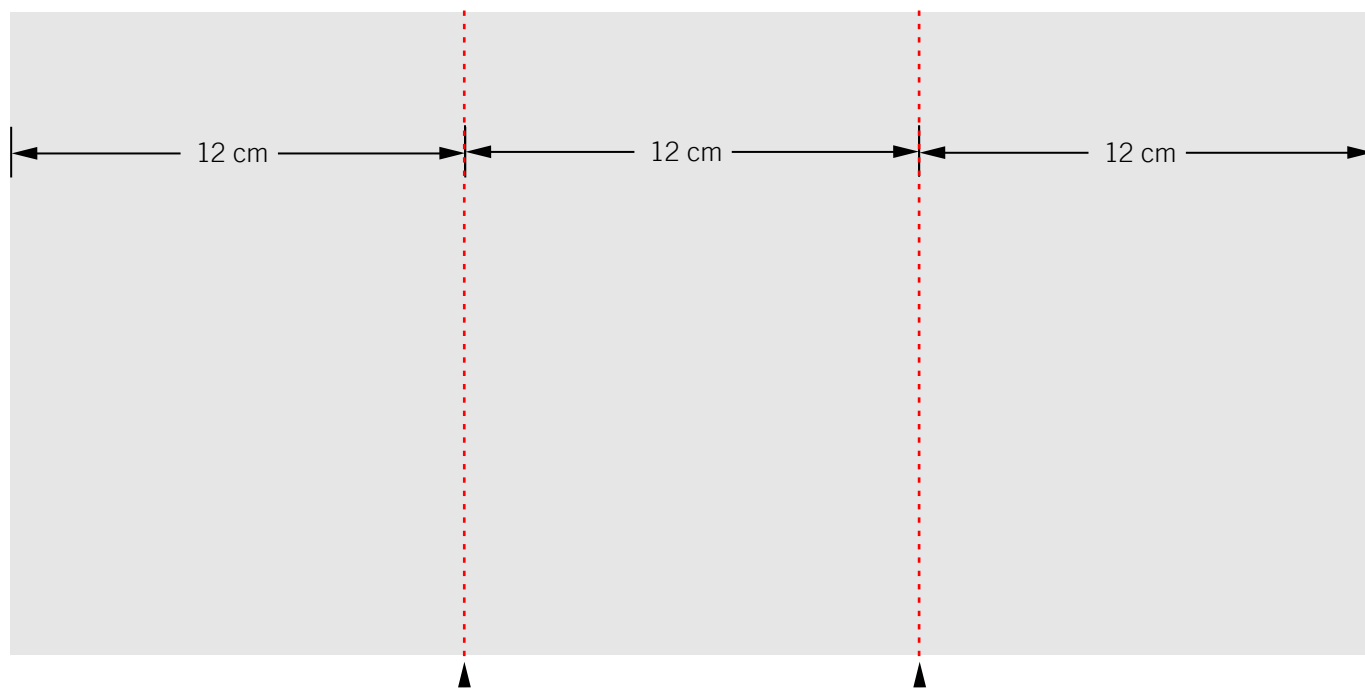

STEP 3

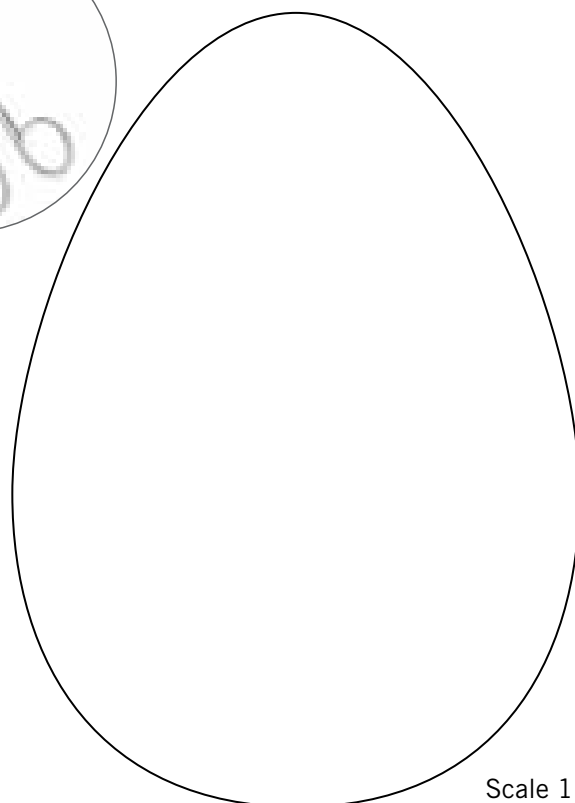
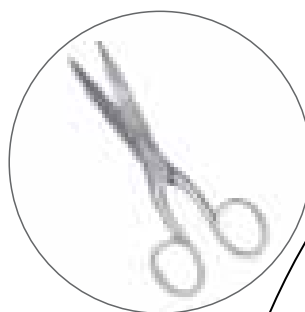
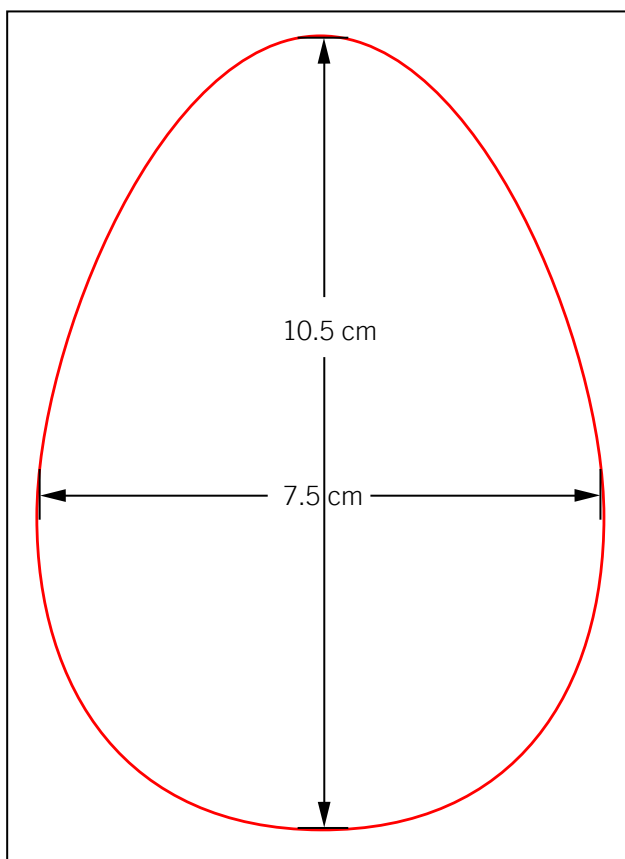

Scale 1:1

STEP 4

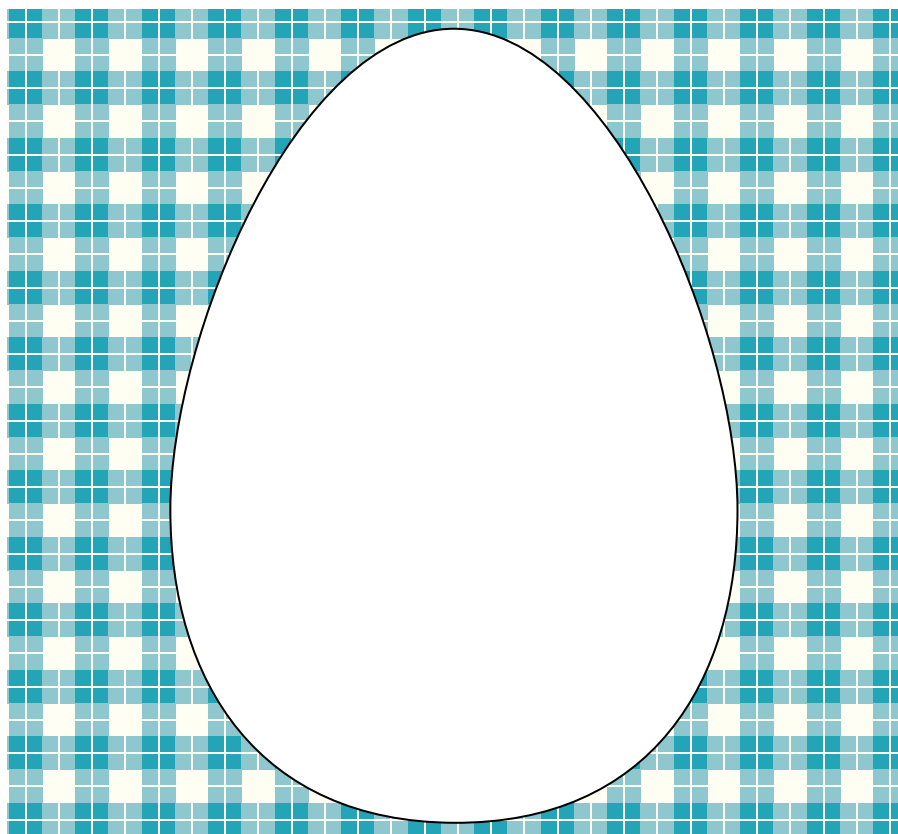

STEP 5

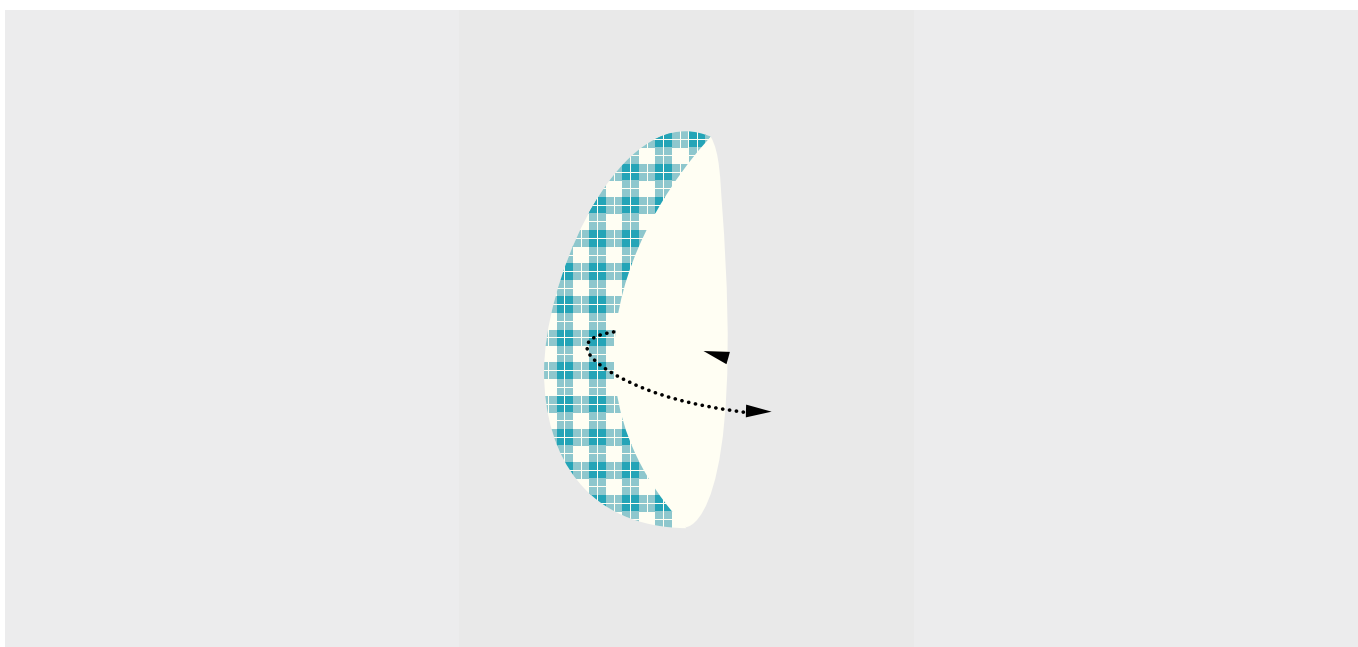

Scale 1:2



STEP 6

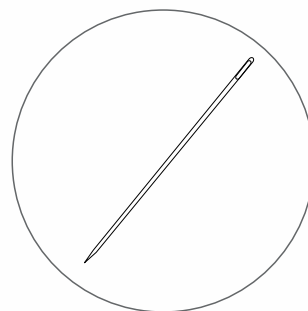
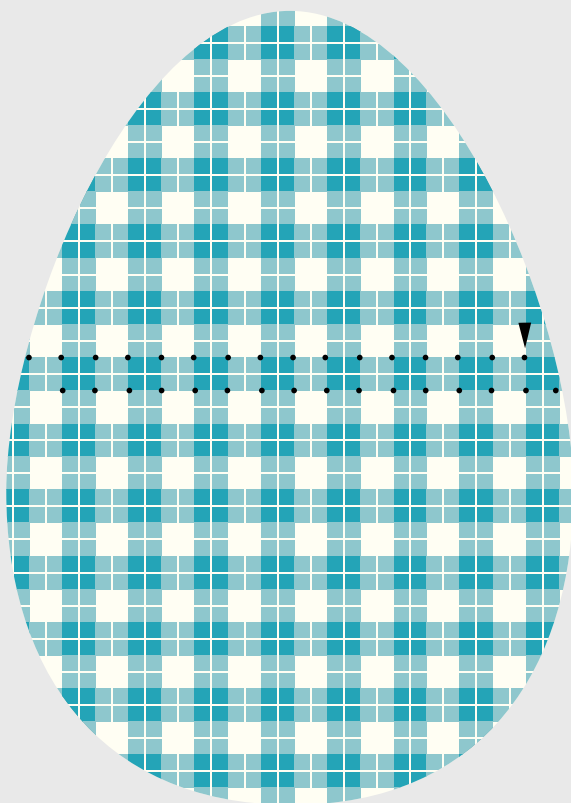

Scale 1:1

STEP 7

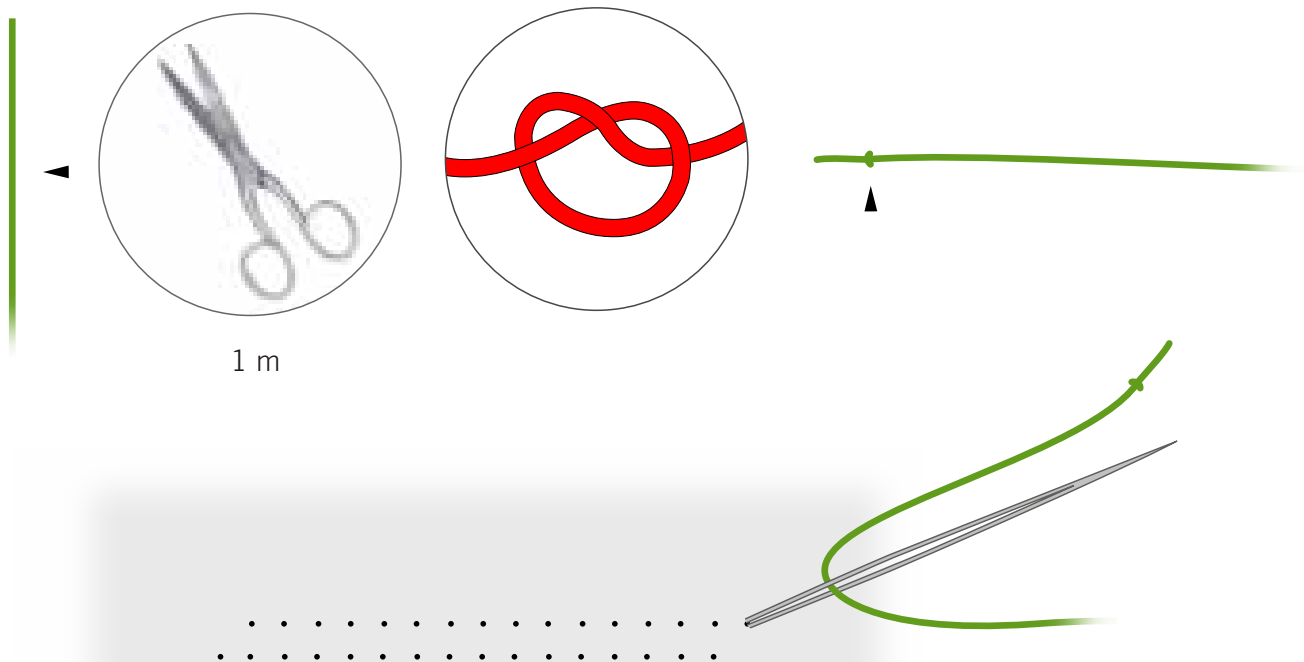

1 m

STEP 8

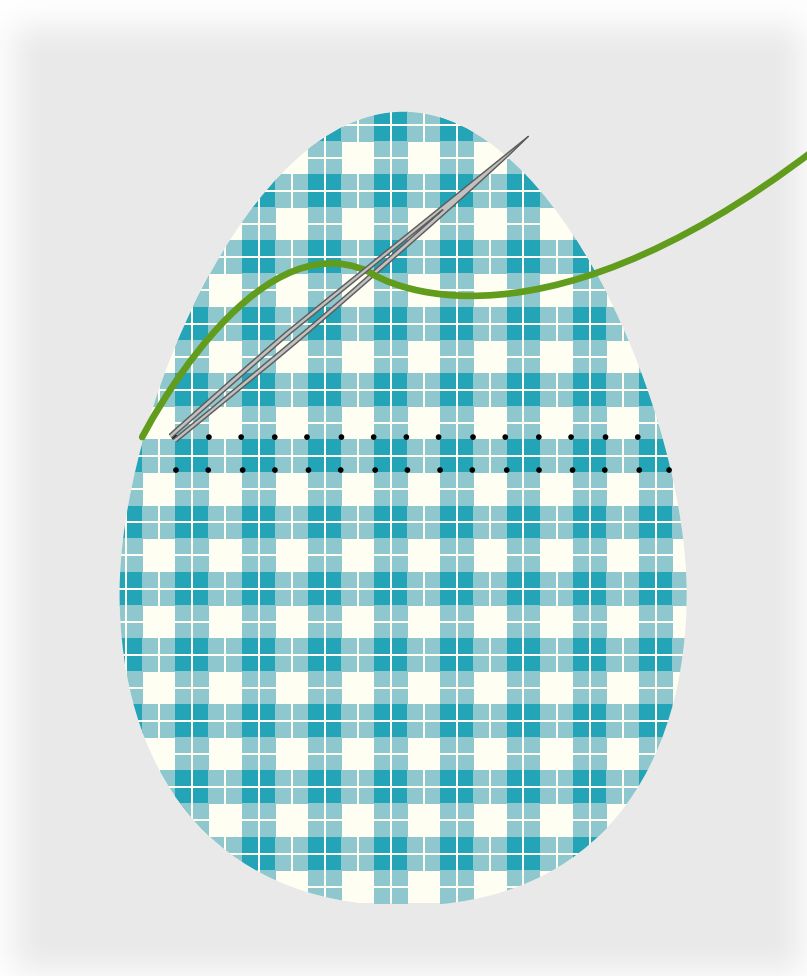

Repeat

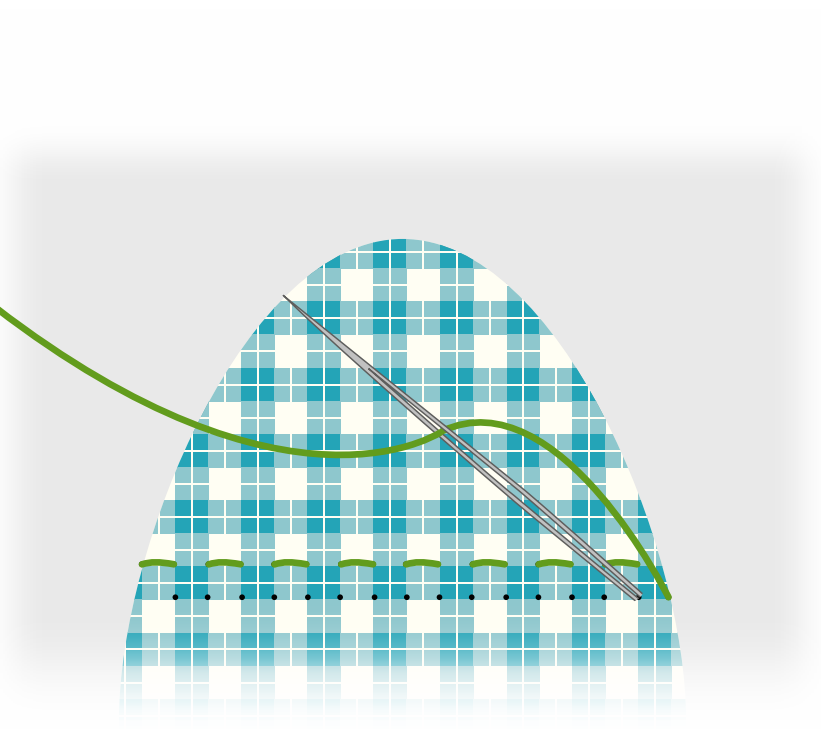

Repeat

STEP 9

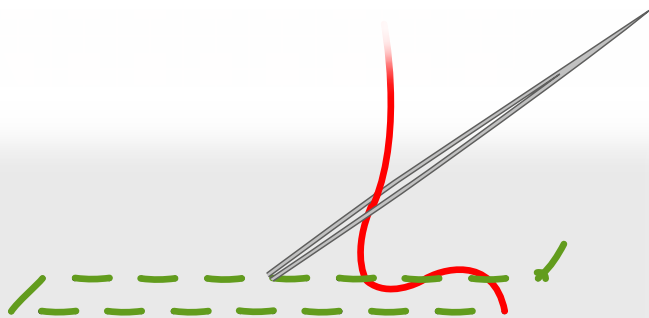

STEP 10

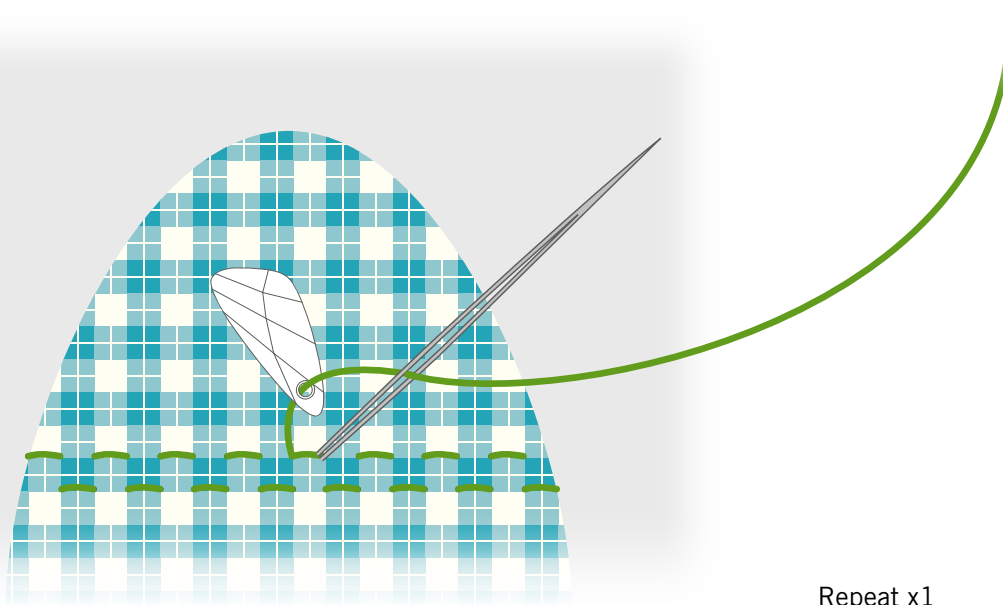

Repeat x1

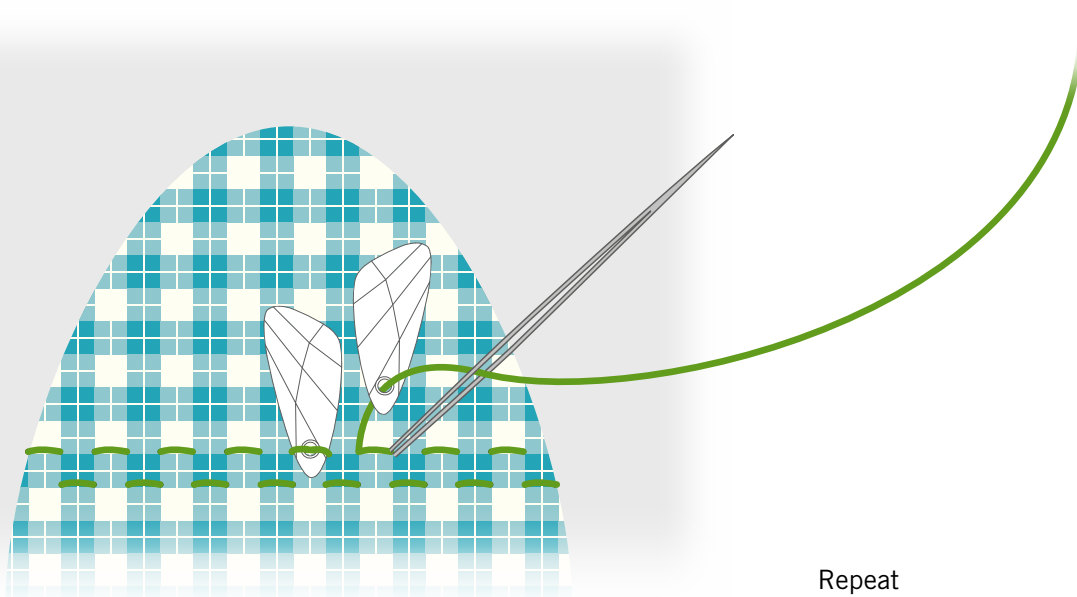

Repeat

STEP 11

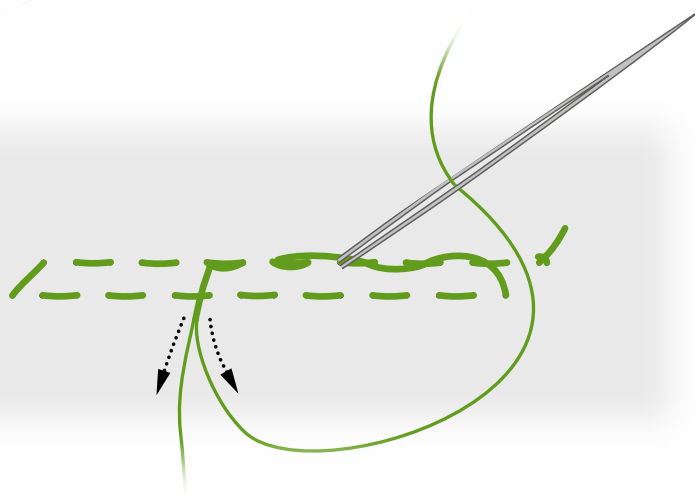

STEP 12

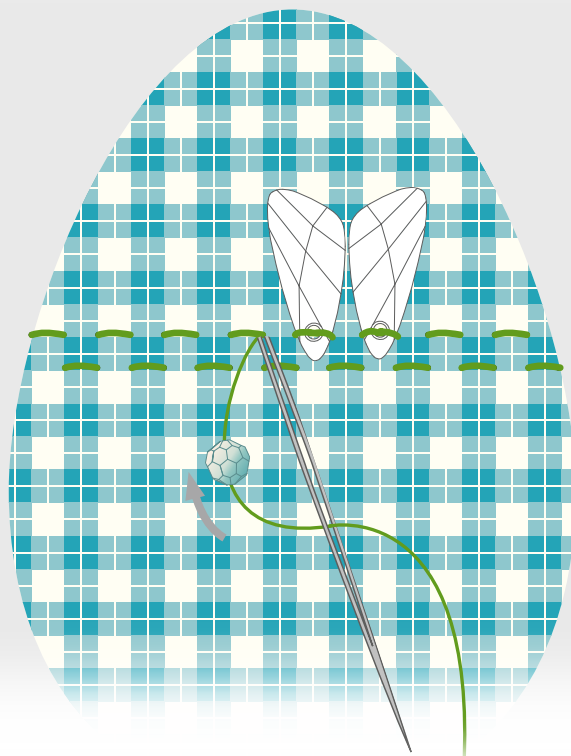

Repeat x6

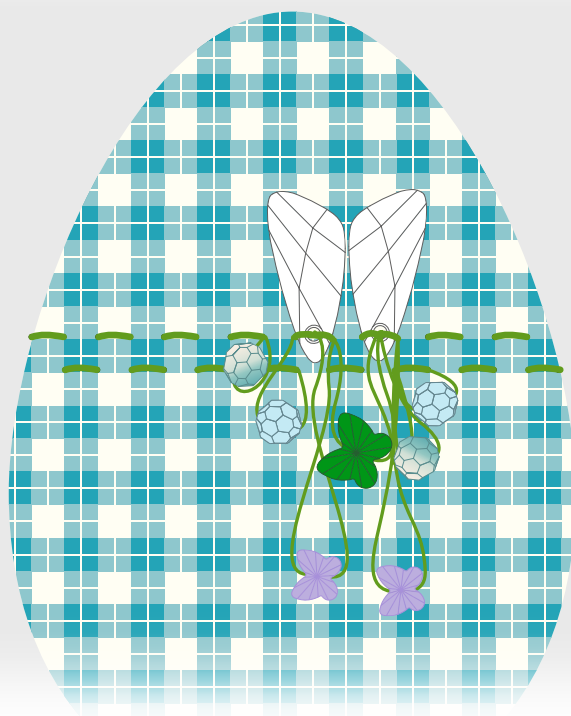

STEP 13 -

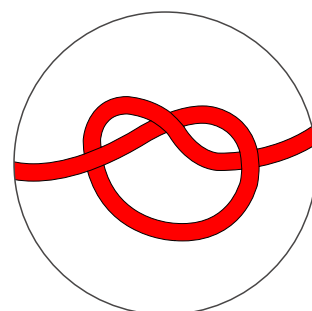
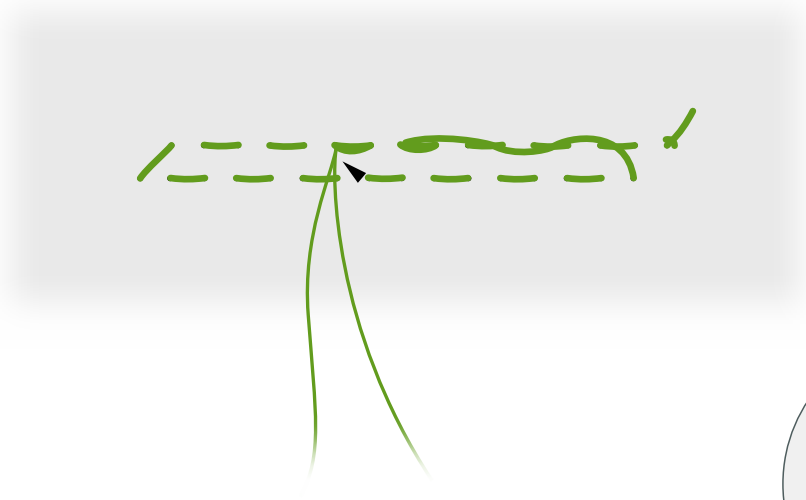

x2

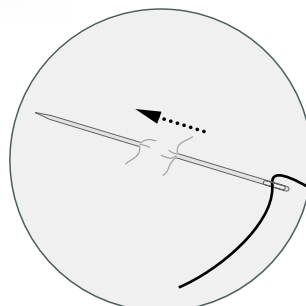

x4



STEP 14



0.7 cm

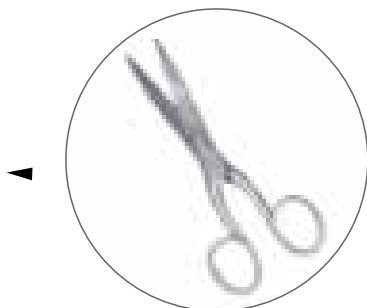

8 cm

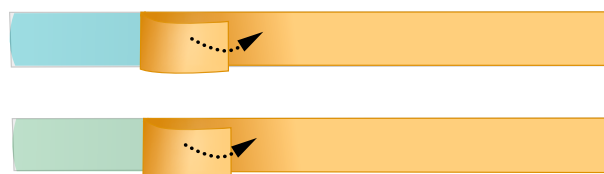

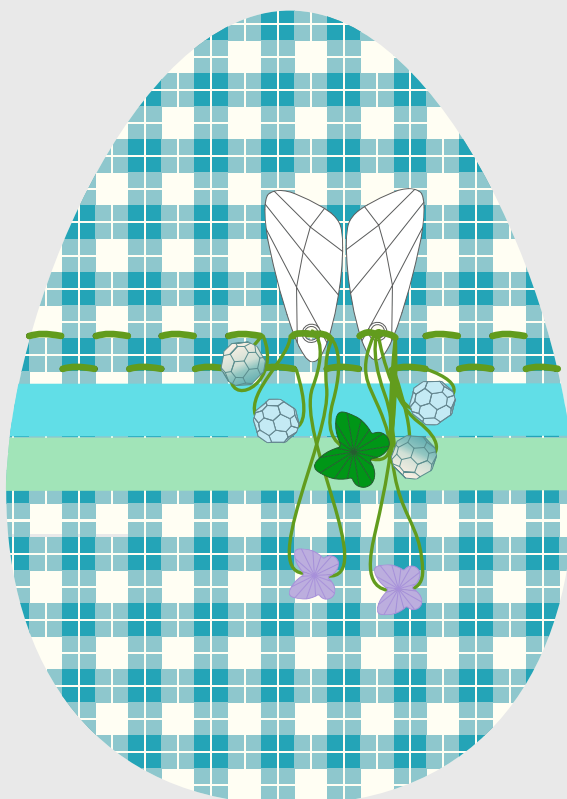

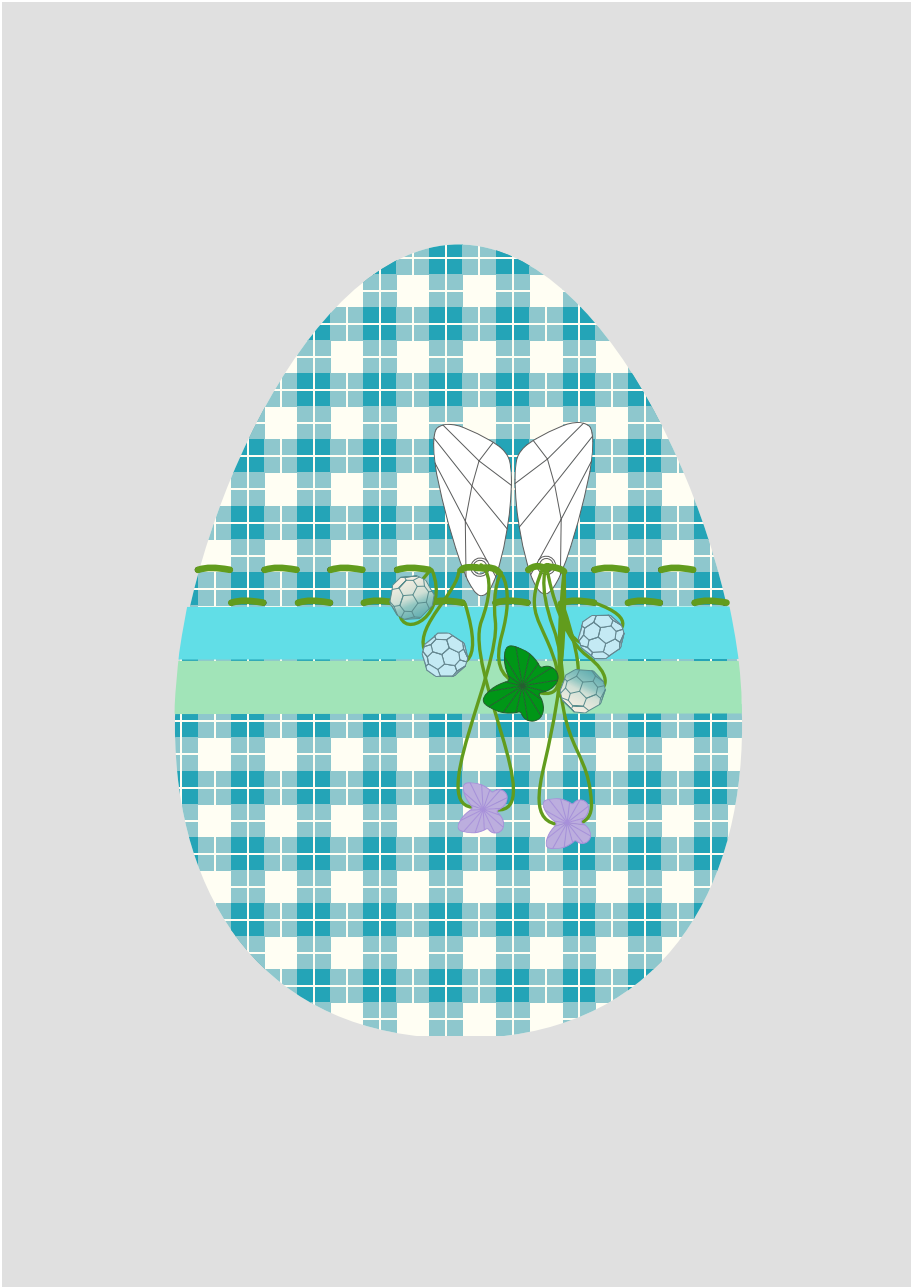

CREATE YOUR STYLE with SWAROVSKI ELEMENTS Design Project

Easter Egg Card

- STEP 1: Cut a 36x17 cm rectangle out of cardboard.
- STEP 2: Without cutting all the way through the cardboard, carve 2 lines, 12 cm apart into cardboard as shown in the illustration. These lines will help later in folding the card.
- STEP 3: To make the egg, stencil, print and cut out the egg pattern (see step 3 of the illustration) with the dimensions of 10.5 cm height and 7.5 cm width.
- STEP 4: Place the stencil onto the pattern paper and trace an outline of the egg and cut out the pattern.
- STEP 5: Glue the pattern exactly on the middle of the cardboard.
- STEP 6: Punch holes into the pattern with the help of a needle.
- STEP 7: Thread the embroidery needle with 1 m of embroidery yarn and make a knot on one end of the thread. Pierce the needle through to the front side of the cardboard.
- STEP 8: Stitch over to the back side through the next hole and repeat this step until you reach the other end of the pattern. Similarly stitch the second row as well as shown in illustration.
- STEP 9: Stitch over to the point where the Swarovski Beads will be attached on the front side of the pattern, stitching under the existing stitches to secure the thread well.
- STEP 10: Insert the first Swarovski Pendant art. 6690 and stitch over to the back side and repeat to secure the Pendant. Repeat this step to attach the second Pendant as shown in illustration.
- STEP 11: Split the embroidery thread into two parts at the back side of the pattern and pierce the needle over to the front side where the next crystal will be attached.
- STEP 12: Insert the first Swarovski Bead art. 5000 6 mm Pacific Opal and form a loop before you pierce through to the back side. Repeat this step to apply the following Swarovski Beads:
- 5000 6 mm Aquamarine
 - 5754 6 mm Provence Lavender
 - 5754 8 mm Fern Green
 - 5754 6 mm Provence Lavender
 - 5000 6 mm Pacific Opal
 - 5000 6 mm Aquamarine
- STEP 13: At the back side of the pattern tie a knot with the other thread as shown in the illustration. Secure the leftover thread with 4 backstitches and cut off excess.
- STEP 14: Cut turquoise and light green ribbons to 8 cm length and stick double sided tape on the back of them. Attach the ribbons onto the pattern. Fold the two sides of the card as shown in the illustration.